

TOOLING TECHNOLOGY

BENZ SELECT LINE

BLP EDITION

Angle Heads Type

WSX MONO &

WWX FORTE

Including adapter
and stop block

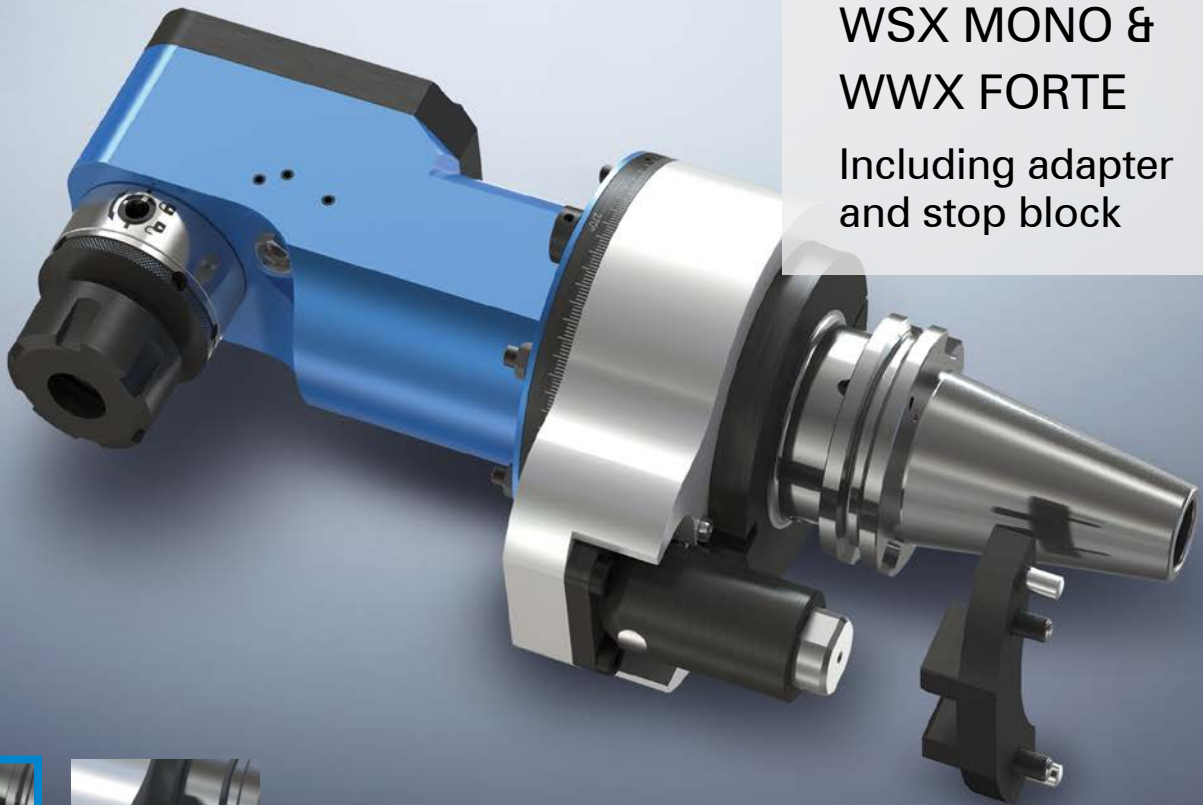

BLP-EDITION



TLP-EDITION

ANGLE HEADS

BENZ quality • Attractive pricing • Quick delivery

BENZ SELECT LINE - BLP-EDITION: PRODUCT RANGE

TYPE WSX MONO

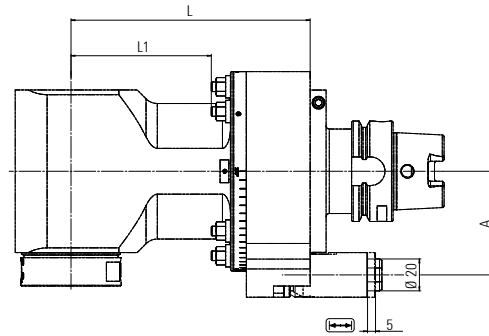

- The drawing shows a sample configuration.
- Drive taper available in HSK-A63, HSK-A100, SK40, SK50, BT40, BT50, CAT40 and CAT50
- Spring loaded locking sleeve with 5 mm stroke
- For TLP-Edition, please contact the Benz Sales Team.

Technical data

TYPE	Output spindle	Angle head	Drive taper	L [mm]	L ₁	A [mm]	i	n [rpm]	M [Nm]	Coolant - EC/IC	Order number
WSX Mono Size 05	S3 x ER25	05	HSK-A63	135	76	65	1	8000	30	●	771WSX00205S3-135SLT
	S3 x ER25	05	HSK-A63	135	76	80	1	8000	30	●	771WSX00405S3-135SLT
	S3 x ER25	05	HSK-A100	135	76	80	1	8000	30	●	772WSX00205S3-135SLT
	S3 x ER25	05	HSK-A100	135	76	110	1	8000	30	●	772WSX00405S3-135SLT
	S3 x ER25	05	SK40	135	76	65	1	8000	30	●	040WSX00205S3-135SLT
	S3 x ER25	05	SK40	135	76	80	1	8000	30	●	040WSX00405S3-135SLT
	S3 x ER25	05	SK50	135	76	80	1	8000	30	●	042WSX00205S3-135SLT
	S3 x ER25	05	SK50	135	76	110	1	8000	30	●	042WSX00405S3-135SLT
	S3 x ER25	05	BT40	135	76	65	1	8000	30	●	039WSX00205S3-135SLT
	S3 x ER25	05	BT40	135	76	80	1	8000	30	●	039WSX00405S3-135SLT
	S3 x ER25	05	BT50	135	76	80	1	8000	30	●	011WSX00205S3-135SLT
	S3 x ER25	05	BT50	135	76	110	1	8000	30	●	011WSX00405S3-135SLT
	S3 x ER25	05	CAT40	135	76	65	1	8000	30	●	377WSX00205S3-135SLT
	S3 x ER25	05	CAT40	135	76	80	1	8000	30	●	377WSX00405S3-135SLT
WSX Mono Size 07	S4 x ER32	07	HSK-A63	150	88	65	1	6000	70	●	771WSX00207S4-150SLT
	S4 x ER32	07	HSK-A63	150	88	80	1	6000	70	●	771WSX00407S4-150SLT
	S4 x ER32	07	HSK-A100	150	88	80	1	6000	70	●	772WSX00207S4-150SLT
	S4 x ER32	07	HSK-A100	150	88	110	1	6000	70	●	772WSX00407S4-150SLT
	S4 x ER32	07	SK40	150	88	65	1	6000	70	●	040WSX00207S4-150SLT
	S4 x ER32	07	SK40	150	88	80	1	6000	70	●	040WSX00407S4-150SLT
	S4 x ER32	07	SK50	150	88	80	1	6000	70	●	042WSX00207S4-150SLT
	S4 x ER32	07	SK50	150	88	110	1	6000	70	●	042WSX00407S4-150SLT
	S4 x ER32	07	BT40	150	88	65	1	6000	70	●	039WSX00207S4-150SLT
	S4 x ER32	07	BT40	150	88	80	1	6000	70	●	039WSX00407S4-150SLT
	S4 x ER32	07	BT50	150	88	80	1	6000	70	●	011WSX00207S4-150SLT
	S4 x ER32	07	BT50	150	88	110	1	6000	70	●	011WSX00407S4-150SLT
	S4 x ER32	07	CAT40	150	88	65	1	6000	70	●	377WSX00207S4-150SLT
	S4 x ER32	07	CAT40	150	88	80	1	6000	70	●	377WSX00407S4-150SLT
S4 x ER32	07	CAT50	150	88	80	1	6000	70	●	107WSX00207S4-150SLT	
S4 x ER32	07	CAT50	150	88	110	1	6000	70	●	107WSX00407S4-150SLT	

Scope of delivery: Angle head with modular quick-change system BENZ Solidfix® including 1 adapter (Type ER Collet) and 1 stop block

BENZ SELECT LINE - BLP-EDITION: PRODUCT RANGE

TYPE WWX FORTE

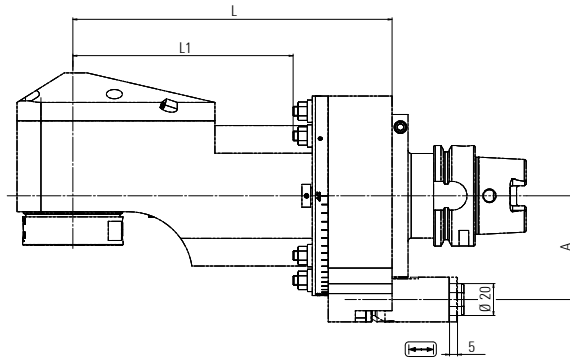

- i – The drawing shows a sample configuration.
- Drive taper available in HSK-A63, HSK-A100, SK40, SK50, BT40, BT50, CAT40 and CAT50
- Spring loaded locking sleeve with 5 mm stroke
- For TLP-Edition, please contact the Benz Sales Team.

Technical data

TYPE	Output spindle	Angle head	Drive taper	L [mm]	L ₁	A [mm]	i	n [rpm]	M [Nm]	Coolant - EC/IC	Order number
WWX Forte Size 05	S3 x ER25	05	HSK-A63	172	113	65	1	8000	30	●	771WWX00205S3-172SLT
	S3 x ER25	05	HSK-A63	172	113	65	1	8000	30	●	711WWX00205S3-172SLT
	S3 x ER25	05	HSK-A63	172	113	80	1	8000	30	●	771WWX00405S3-172SLT
	S3 x ER25	05	HSK-A63	172	113	80	1	8000	30	●	711WWX00405S3-172SLT
	S3 x ER25	05	HSK-A100	172	113	80	1	8000	30	●	772WWX00205S3-172SLT
	S3 x ER25	05	HSK-A100	172	113	80	1	8000	30	●	713WWX00205S3-172SLT
	S3 x ER25	05	HSK-A100	172	113	110	1	8000	30	●	772WWX00405S3-172SLT
	S3 x ER25	05	HSK-A100	172	113	110	1	8000	30	●	713WWX00405S3-172SLT
	S3 x ER25	05	SK40	172	113	65	1	8000	30	●	040WWX00205S3-172SLT
	S3 x ER25	05	SK40	172	113	65	1	8000	30	●	240WWX00205S3-172SLT
	S3 x ER25	05	SK40	172	113	80	1	8000	30	●	040WWX00405S3-172SLT
	S3 x ER25	05	SK40	172	113	80	1	8000	30	●	240WWX00405S3-172SLT
	S3 x ER25	05	SK50	172	113	80	1	8000	30	●	042WWX00205S3-172SLT
	S3 x ER25	05	SK50	172	113	80	1	8000	30	●	242WWX00205S3-172SLT
	S3 x ER25	05	SK50	172	113	110	1	8000	30	●	042WWX00405S3-172SLT
	S3 x ER25	05	SK50	172	113	110	1	8000	30	●	242WWX00405S3-172SLT
	S3 x ER25	05	BT40	172	113	65	1	8000	30	●	039WWX00205S3-172SLT
	S3 x ER25	05	BT40	172	113	65	1	8000	30	●	339WWX00205S3-172SLT
	S3 x ER25	05	BT40	172	113	80	1	8000	30	●	039WWX00405S3-172SLT
	S3 x ER25	05	BT40	172	113	80	1	8000	30	●	339WWX00405S3-172SLT
	S3 x ER25	05	BT50	172	113	80	1	8000	30	●	011WWX00205S3-172SLT
	S3 x ER25	05	BT50	172	113	80	1	8000	30	●	466WWX00205S3-172SLT
	S3 x ER25	05	BT50	172	113	110	1	8000	30	●	011WWX00405S3-172SLT
	S3 x ER25	05	BT50	172	113	110	1	8000	30	●	466WWX00405S3-172SLT
	S3 x ER25	05	CAT40	172	113	65	1	8000	30	●	377WWX00205S3-172SLT
	S3 x ER25	05	CAT40	172	113	65	1	8000	30	●	378WWX00205S3-172SLT
	S3 x ER25	05	CAT40	172	113	80	1	8000	30	●	377WWX00405S3-172SLT
	S3 x ER25	05	CAT40	172	113	80	1	8000	30	●	378WWX00405S3-172SLT
	S3 x ER25	05	CAT50	172	113	80	1	8000	30	●	107WWX00205S3-172SLT
	S3 x ER25	05	CAT50	172	113	80	1	8000	30	●	354WWX00205S3-172SLT
	S3 x ER25	05	CAT50	172	113	110	1	8000	30	●	107WWX00405S3-172SLT
	S3 x ER25	05	CAT50	172	113	110	1	8000	30	●	534WWX00405S3-172SLT

Scope of delivery: Angle head with modular quick-change system BENZ Solidfix® including 1 adapter (Type ER Collet) and 1 stop block

BENZ SELECT LINE - BLP-EDITION: PRODUCT RANGE

Technical data

TYPE	Output spindle	Angle head	Drive taper	L [mm]	L ₁	A [mm]	i	n [rpm]	M [Nm]	Coolant - EC/IC	Order number
WWX Forte Size 07	S4 x ER32	07	HSK-A63	200	138	65	1	6000	70	●	771WWX00207S4-200SLT
	S4 x ER32	07	HSK-A63	200	138	65	1	6000	70	●	711WWX00207S4-200SLT
	S4 x ER32	07	HSK-A63	200	138	80	1	6000	70	●	771WWX00407S4-200SLT
	S4 x ER32	07	HSK-A63	200	138	80	1	6000	70	●	711WWX00407S4-200SLT
	S4 x ER32	07	HSK-A100	200	138	80	1	6000	70	●	772WWX00207S4-200SLT
	S4 x ER32	07	HSK-A100	200	138	80	1	6000	70	●	713WWX00207S4-200SLT
	S4 x ER32	07	HSK-A100	200	138	110	1	6000	70	●	772WWX00407S4-200SLT
	S4 x ER32	07	HSK-A100	200	138	110	1	6000	70	●	713WWX00407S4-200SLT
	S4 x ER32	07	SK40	200	138	65	1	6000	70	●	040WWX00207S4-200SLT
	S4 x ER32	07	SK40	200	138	65	1	6000	70	●	240WWX00207S4-200SLT
	S4 x ER32	07	SK40	200	138	80	1	6000	70	●	040WWX00407S4-200SLT
	S4 x ER32	07	SK40	200	138	80	1	6000	70	●	240WWX00407S4-200SLT
	S4 x ER32	07	SK50	200	138	80	1	6000	70	●	042WWX00207S4-200SLT
	S4 x ER32	07	SK50	200	138	80	1	6000	70	●	242WWX00207S4-200SLT
	S4 x ER32	07	SK50	200	138	110	1	6000	70	●	042WWX00407S4-200SLT
	S4 x ER32	07	SK50	200	138	110	1	6000	70	●	242WWX00407S4-200SLT
	S4 x ER32	07	BT40	200	138	65	1	6000	70	●	039WWX00207S4-200SLT
	S4 x ER32	07	BT40	200	138	65	1	6000	70	●	339WWX00207S4-200SLT
	S4 x ER32	07	BT40	200	138	80	1	6000	70	●	039WWX00407S4-200SLT
	S4 x ER32	07	BT40	200	138	80	1	6000	70	●	339WWX00407S4-200SLT
	S4 x ER32	07	BT50	200	138	80	1	6000	70	●	011WWX00207S4-200SLT
	S4 x ER32	07	BT50	200	138	80	1	6000	70	●	466WWX00207S4-200SLT
	S4 x ER32	07	BT50	200	138	110	1	6000	70	●	011WWX00407S4-200SLT
	S4 x ER32	07	BT50	200	138	110	1	6000	70	●	466WWX00407S4-200SLT
	S4 x ER32	07	CAT40	200	138	65	1	6000	70	●	377WWX00207S4-200SLT
	S4 x ER32	07	CAT40	200	138	65	1	6000	70	●	378WWX00207S4-200SLT
	S4 x ER32	07	CAT40	200	138	80	1	6000	70	●	377WWX00407S4-200SLT
	S4 x ER32	07	CAT40	200	138	80	1	6000	70	●	378WWX00407S4-200SLT
	S4 x ER32	07	CAT50	200	138	80	1	6000	70	●	107WWX00207S4-200SLT
	S4 x ER32	07	CAT50	200	138	80	1	6000	70	●	354WWX00207S4-200SLT
	S4 x ER32	07	CAT50	200	138	110	1	6000	70	●	107WWX00407S4-200SLT
	S4 x ER32	07	CAT50	200	138	110	1	6000	70	●	534WWX00407S4-200SLT

Scope of delivery: Angle head with modular quick-change system BENZ Solidfix® including 1 adapter (Type ER Collet) and 1 stop block

ACCESSORIES

TYPE	Size	Order number
	S3 x ER25	693.130E534
	S4 x ER32	694.130E639

TYPE	for A [mm]	Order number
	A 65	K00600-055/075
	A 80	K00600-070/090
	A 110	K00600-100/120

OPTIONAL ACCESSORIES

TYPE	Size	Order number
	S3 x ER25	S3-SET-001
	S4 x ER32	S4-SET-001