

# CORNER NOTCHING UNIT - CLASSIC LINE

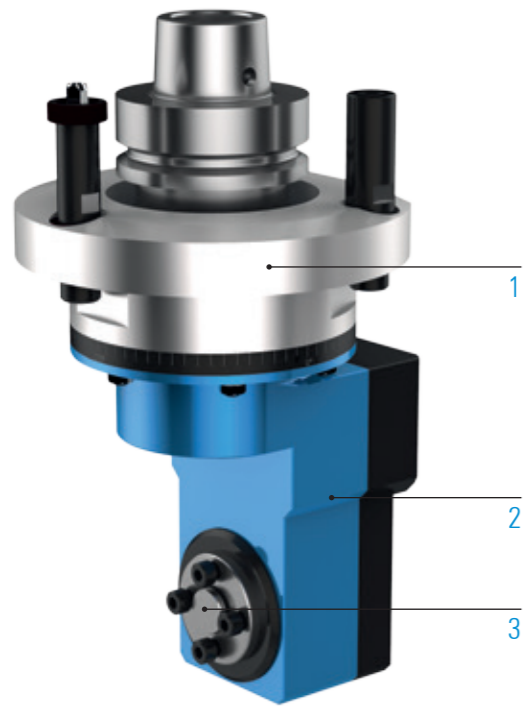

## ANGULO

### TECHNICAL DATA

Lubrication	Grease
Max. drive speed $n_2$	10,000 rpm
Transmission ratio ( $n_1: n_2$ )	1:1.3
Max. drive torque $M_2$	20 Nm
Weight	about 4.5 kg



### STANDARD DESIGN

- 1  Machine Connection  
HSK - F63
- 2  Head length  
M
- 3  Output spindle  
Centring Ø16

### MACHINING



Drilling



Milling

### SPECIFICATIONS

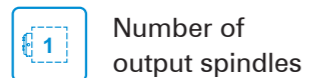

Number of output spindles



Axis angle



C-angle



Grease lubrication

### VIDEO



Angle head - live in the application  
Scan QR code or go to:  
[www.youtube.com/BENZWerkzeugsysteme](http://www.youtube.com/BENZWerkzeugsysteme)

### ORDER DIRECTLY



Inquiry form:  
[www.benz-tools.de/en/products](http://www.benz-tools.de/en/products)

### ADDITIONAL OPTIONS: MODULAR DESIGN

1



### MACHINE CONNECTION



 For further information see p. 106

2



### HEAD LENGTH



 For further information see p. 107

3



### OUTPUT SPINDLE



 For further information see p. 108