

SCHWENKKOPF MIT DIGITALANZEIGE – PREMIUM LINE

FLEX D

MASCHINENANBINDUNGSVARIANTEN

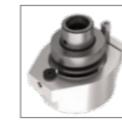
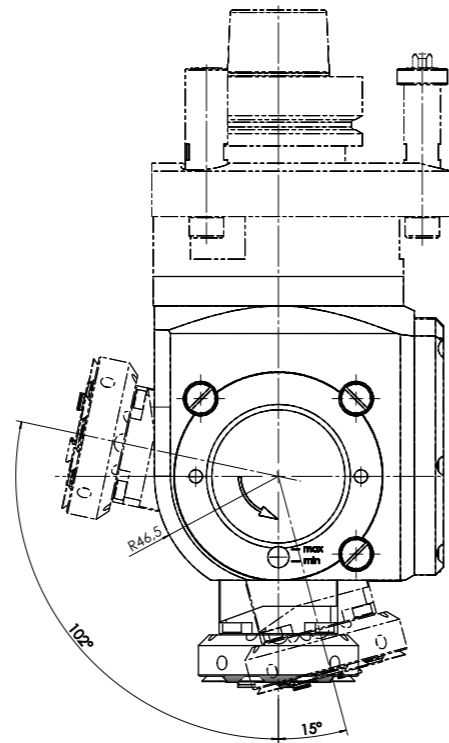
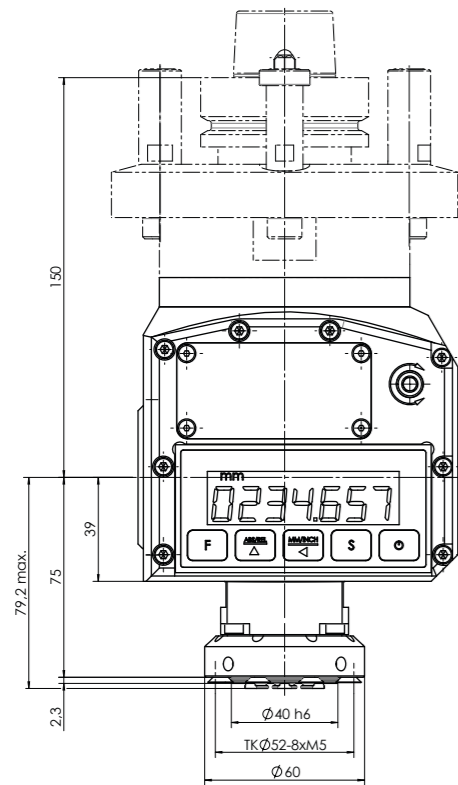

HSK - F63
BIESSE

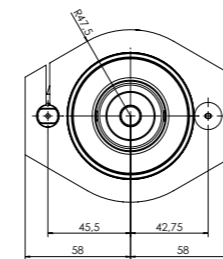
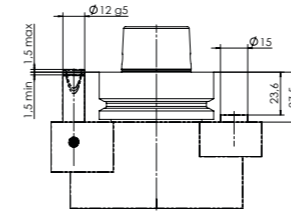

HSK - F63
Busellato

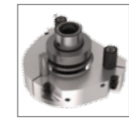
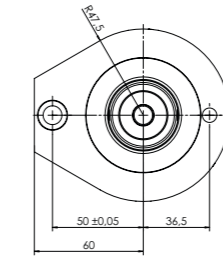
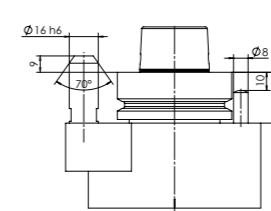

HSK - F63
Felder

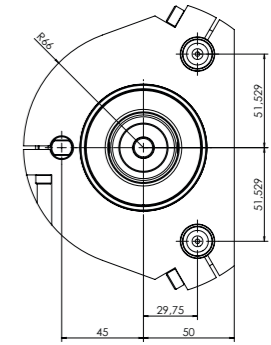
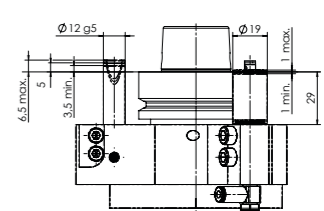

HSK - F63
HOMAG / WEEKE /
WEINMANN

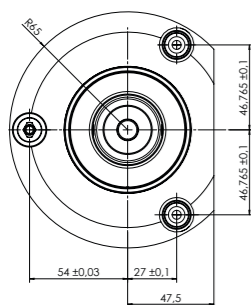
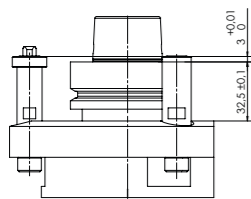

HSK - F63
IMA

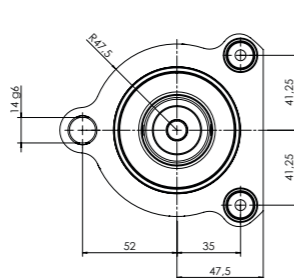
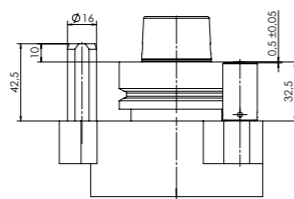

HSK - F63
Masterwood

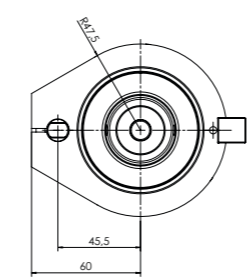
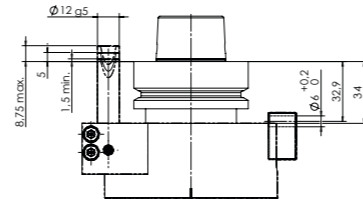

HSK - F63
SCM

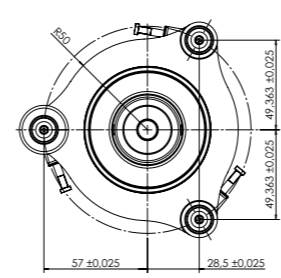
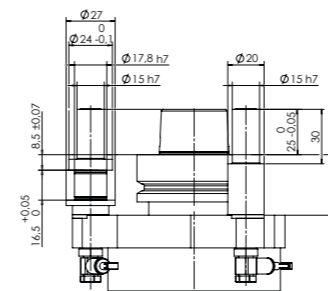

HSK - F63
SCM

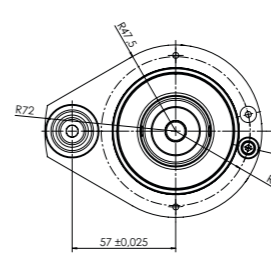
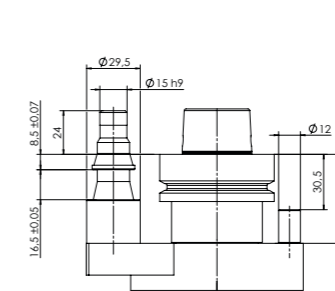

HSK - F63
Weinig

