

BENZ - Specialist for tool systems

- One of the leading companies in manufacturing of live tools for a variety of lathes and machining centers
- Over twenty five years of experience in developing and manufacturing of live tools.
- High standards of quality
- High competence in development, engineering and manufacturing
- Product range involves, beside live tools, exchangeable units, like angle heads, multi spindle heads and high speed spindles, 5-axis-units and workholding systems.
- Dynamic corporate development, high vertical range of manufacture



Live Tools

▶ **High availability to deliver**

Online stock request www.benz-tools.com/stockrequest

▶ **High quality through X-line gear technology**

Higher torque, higher revolutions (rpm), smoother and more quiet running, less heat development, durable and a compact design.

www.benz-tools.com

Full-range supplier of live tools for:

Accuway
 Baruffaldi Revolver
 Biglia
 Boehringer
 Brinkmann
 Cincinnati Cinturn
 Citizen
 CMZ
 Colchester
 Daewoo
 Dainichi
 Doosan
 Duplomatic*
 EMAG*

EMCO
 Ernault
 Famar
 +GF+
Gildemeister*
 Graziano
Haas*
 Hardinge
 Heid
 Hessapp
 Heyligenstaedt
 Hitachi Seiki
 Hwacheon
 Hyundai

INDEX
 Kern
 Laru Revolver
 Leadwell
 Max Müller
Mazak*
 Miyano
 Monforts
MORI SEIKI*
 Murata | Muratec
 Nakamura
 Niles
OKUMA*
 Pittler

Sauter Revolver*
 Schaublin
 Schütte
 Seidler
 Spinner
 Star
 Takamaz
 Takisawa
 Topper
 Traub
 Weiler
 Weisser
 WFL
 WIA



Use of live tools on lathes:

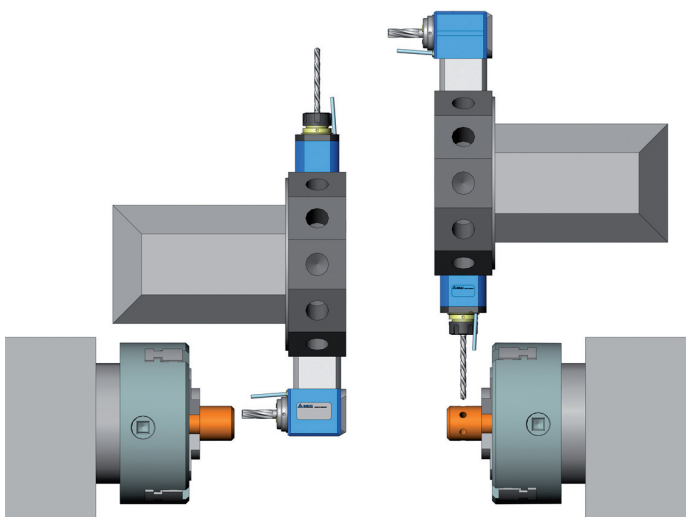

Star turret

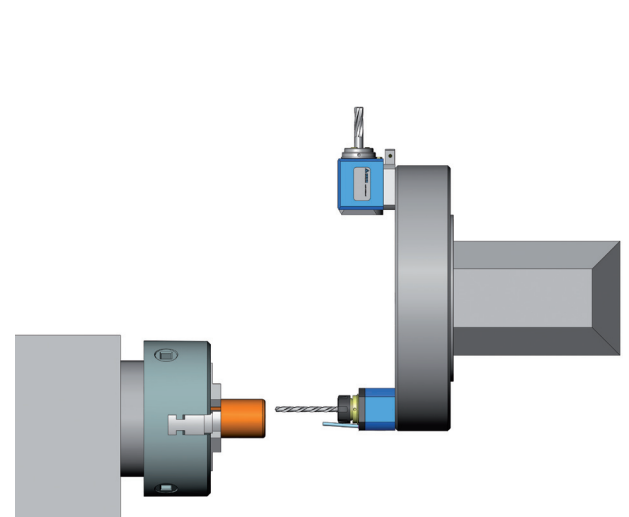

Disc turret

Please ask our BENZ team
for more information.
We are pleased to help you!

Designs

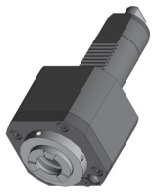

Axial drilling and milling head

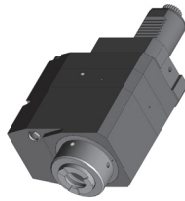

Axial drilling and milling head
ratio into fast and into slow

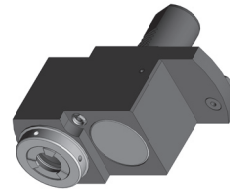

Axial drilling and milling head
offset

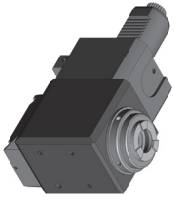

Radial drilling and milling head

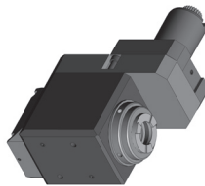

Radial drilling and milling head
offset

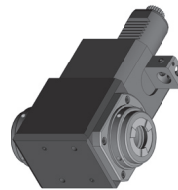

Radial drilling and milling head
with two spindles

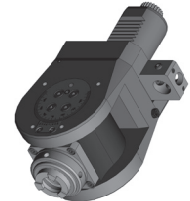

Swivel head

On request there are also multi-spindle-heads (axial, radial), radial key cutter (y-adjustable), inside milling heads, cross milling heads and angle drilling and milling heads (fixed angles, radial and axial) available.

Gears

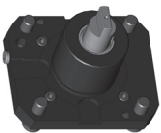

BMT

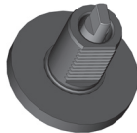

DIN 1809



DIN 5480

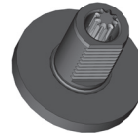

DIN 5482

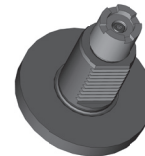

Coupler
single-stage

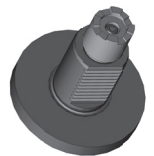

Coupler
double stage

Highlights

1 Modular Systems

BMS, Coromant Capto®, HSK, HSK-T, KM™

1



2 New alignment system for live tools

Enables a fast and convenient vernier adjustment of live tools for keeping a durable position even after repeating changes.

Your advantages: particularly user-friendly and time saving

2

3 Swivel head GD 49 ± 100° with internal coolant

Angle adjustable and lockable at will, use of tools with internal coolant possible
For live tools with shank Ø 40 mm

Your advantages: More power through X-line gear technology | Geometry and weight optimized and therefore no interference with adjacent turret places | Higher revolutions | Partly modular design for a short delivery time
Efficient operation at small and medium batch sizes with inclined drillings and millings.

3

